

**MB Vito  
langer Radstand**

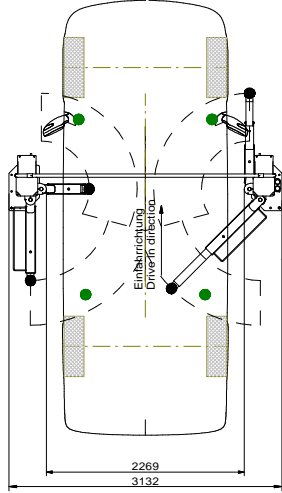

**VW AMAROK**

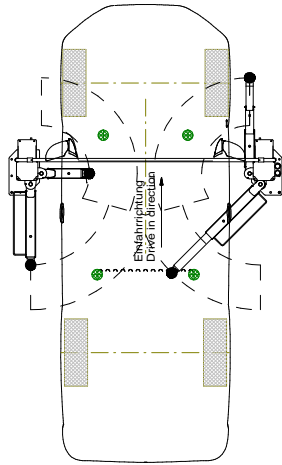

**BMW 7er**

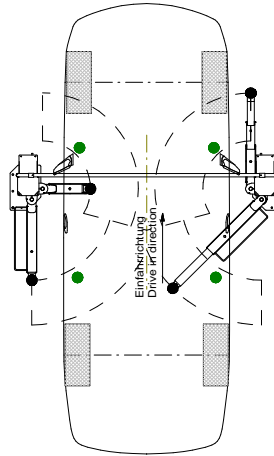

**VW T5**

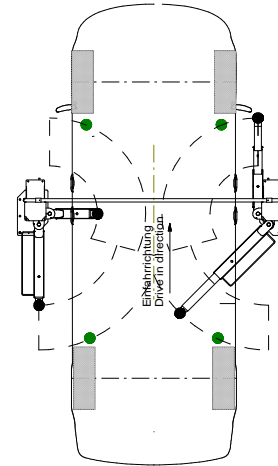

**Porsche Cayenne**

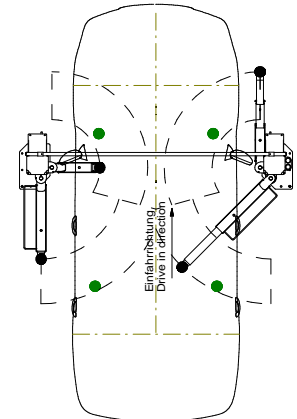

**Audi A1**

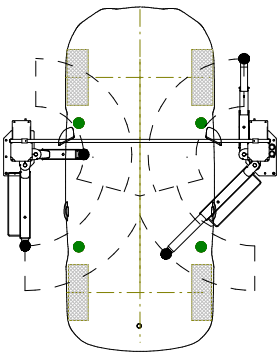

**VW Golf**

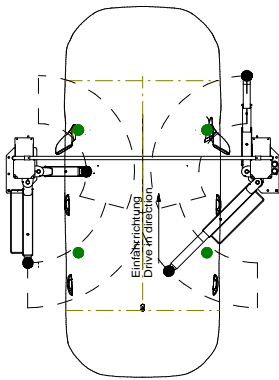

**Audi Q7**

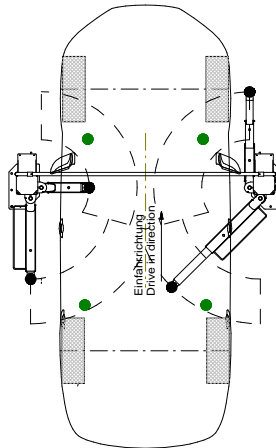

**smart**

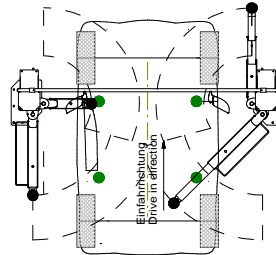

**BMW Z4**

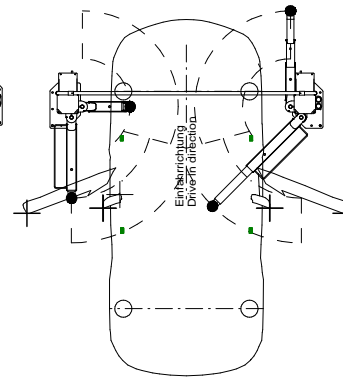

**BMW 3er**

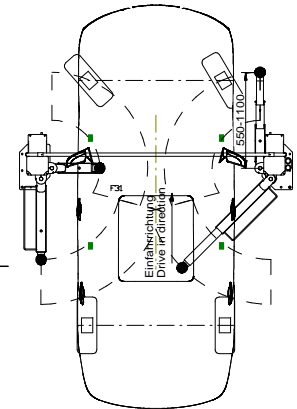

Alle Maße in Millimeter  
all dimensions in millimeter

Mass- und Konstruktionsänderungen vorbehalten!  
subject to alterations!

										THIRD ANGLE PROJECTION	<b>SPMA32</b> <b>ROTARY LIFT</b> A DOVER COMPANY
						UNLESS OTHERWISE NOTED: ANGULAR DIMENSIONS: 1° OTHER DIMENSIONS: 1) 0.8mm (<305mm) 2) 1.6mm (>or= 305mm)	DO NOT SCALE DRAWING UNLESS OTHERWISE SPECIFIED: 0.8mm MIN. CORNER BREAK REMOVE ALL BURRS				
						NOTES: <b>Tragfähigkeit: max. 3200kg capacity</b>	The design and detail illustrated in this drawing is the property of Rotary Lift. It is being loaned with the expressed condition that it will not be duplicated or used except by permission and is subject to return upon request.				2-Post-Lift-SPMA32_8504-1